

Medium sized linear bearing flange

LM-UD series-LM12UU-UD|LM12-UD

参数信息:

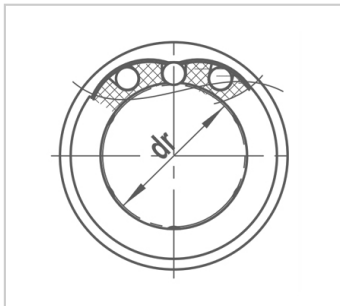
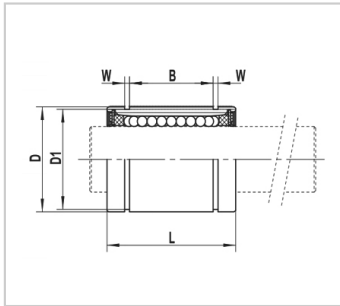

model :

Synthetic resin retainer :	LM12UU-UD
Integral stainless steel retainer :	LM12-UD
Number of steel ball columns :	4
Weight (g) :	54

Main dimensions and tolerances (mm) :

dr :	12
tolerance :	0~-0.010

Main dimensions and tolerances (mm) flange :

D :	21
tolerance :	0~-0.016
L :	47
tolerance :	0~-0.3
B :	30
tolerance :	0~-0.5
W :	1.3
D1 :	20
Eccentricity (um) :	15

Rated load :

C(N) :	630
Co(N) :	810

: